

Circuit-protection overview

- Retrofitting AC-DC sensitive building-site distribution boards
- Residual current protection for a modern house distribution system
- Standards for AC-DC sensitive RCCBs
- Selection tool app
- The right circuit-breaker for any requirements
- The safe way to fill up with electricity
- Remote switching and signalling
- Combined residual current and line protection: RCBO
- Safety³ = DAFDD
- Expert line protection



Retrofitting AC-DC sensitive building-site distribution boards

Construction sites are frequently home to items of electric equipment that could potentially generate smooth DC residual currents in the event of a fault. Examples include cranes, pumps, fans, sand sieves, compactors and masonry saws, to name but a few. According to device standards, type A residual current circuit-breakers must not be subjected to smooth DC residual currents higher than 6 mA. The reason for this is that even low smooth DC residual currents can have a detrimental effect on any type A or type F circuit-breakers, with the result that they are no longer able to provide reliable protection.

Excessive DC residual currents lead to pre-magnetisation of the summation current transformer. In turn, this can change the tripping thresholds and tripping times or cause a complete failure (a phenomenon known as “blinding” because the device cannot see the fault current). In a worst-case scenario, a malfunction may go completely unnoticed.

This means that type B AC-DC sensitive residual current circuit-breakers are the only way to ensure that the power supply on a construction site is completely safe. According to DIN VDE 0100-704 (Requirements for special installations or locations – Construction and demolition site installations), three-phase sockets up to 63 A must always be protected using AC-DC sensitive residual current devices. This is the responsibility of the constructor.



Use electricity safely
on construction sites.



ISΩ

— test-proof and safe —

NEW

ISΩ RCCBs are test-proof. When carrying out periodic testing on electric installations in accordance with DIN VDE 0100-600, this means that the insulation can be measured without having to disconnect the circuit-breakers first. Doepke type B RCCBs in the ISΩ HD design are available with a nominal current of up to 63 A and for a rated residual current of up to 500 mA.

SK

— for reliable system availability —

Type B RCCBs with the SK tripping characteristic curve are ideal for construction sites. They are highly tolerant of operational leakage currents, such as those associated with construction cranes.

MI

— for mobile installations —

When using type B RCCBs in a mobile installation, it is important to check the upstream fixed installation first. If this is being protected by a type A RCCB, the standard requires this RCCB to be replaced – type B RCCBs must not be used downstream of type A circuit-breakers. AC-DC sensitive RCCBs in the MI design (for mobile installations) are the only AC-DC sensitive RCCBs on the market that are allowed to be operated downstream of type A or type F circuit-breakers. This is because of their low tripping threshold in response to DC residual currents of 6 mA DC.

HD

— for harsh environments —

HD (heavy-duty) RCCBs are extremely resistant to corrosion and less sensitive to environmental influences. They are 100 % reliable in all situations, even when they are used in places that are particularly hot or cold, or alternate between the two. They are also more resistant to contamination such as corrosive gases or dust. This makes them absolutely ideal for use on construction sites. They provide non-stop protection whether the equipment is in operation or de-energised.



Residual current protection from Doepke

Type of residual current	A	F	B+	B
for sinusoidal AC residual currents = AC sensitive	■	■	■	■
for pulsating DC residual currents = pulsating current sensitive and AC sensitive	■	■	■	■
for residual currents with mixed frequencies = mixed frequency sensitive		■	■	■
for smooth DC residual currents = AC-DC sensitive			■	■
short-time delayed = less nuisance tripping, e. g. in response to inrush currents or surge currents during thunderstorms		■	■	■
residual current detection up to 20 kHz			■	■
residual current detection up to 150 kHz (Doepke B NK or B SK)				■

DFS type A — Standard protection for circuits with a frequency of 50 Hz. Suitable for scenarios where there is no risk of leakage currents with a mixed frequency component, or of smooth DC residual currents (> 6 mA).

DFS type F — Single-phase frequency converters generate mixed frequencies and are found in many everyday appliances in homes, workshops and offices (e.g. in washing machines, concrete vibrating tools, hammer drills and heating or thermal pumps). Consequently, type F RCCBs provide future-proof protection for homes, offices and industry.

type F:
mixed frequency
sensitive



AC-DC sensitive RCCBs — Multi-phase operated or frequency-controlled electronic equipment can generate smooth DC residual currents in the event of a fault e. g.: cranes, pumps, fans, compactors, concrete vibrating tools, electric vehicle charging stations or even photovoltaic systems. AC-DC sensitive RCCBs are also the optimum form of protection when using consumers with operating frequencies that extend into the kilohertz range. They are stipulated by many standards (see also page 8) and make a particularly important contribution to electrical safety on construction sites (see pages 2 and 3).

Type B NK — for facilities at risk of fire
 — preventive fire protection up to max. 150 kHz
 — upper tripping limit of max. 300 mA
 — satisfies the standards DIN VDE 0664-10, DIN VDE 0664-40
 — exceeds the requirements of standard DIN VDE 0664-400 (type B+)

Type B+ — for facilities at risk of fire
 — fire protection up to max. 20 kHz
 — satisfies standard DIN VDE 0664-400
 — upper tripping limit of 420 mA

Type B SK — high system availability
 — tripping characteristic curve optimised for systems with high operational leakage currents
 — satisfies the standards DIN VDE 0664-10, DIN VDE 0664-40
 — with the ability to detect residual currents up to 150 kHz, it exceeds the requirements of the relevant device standard

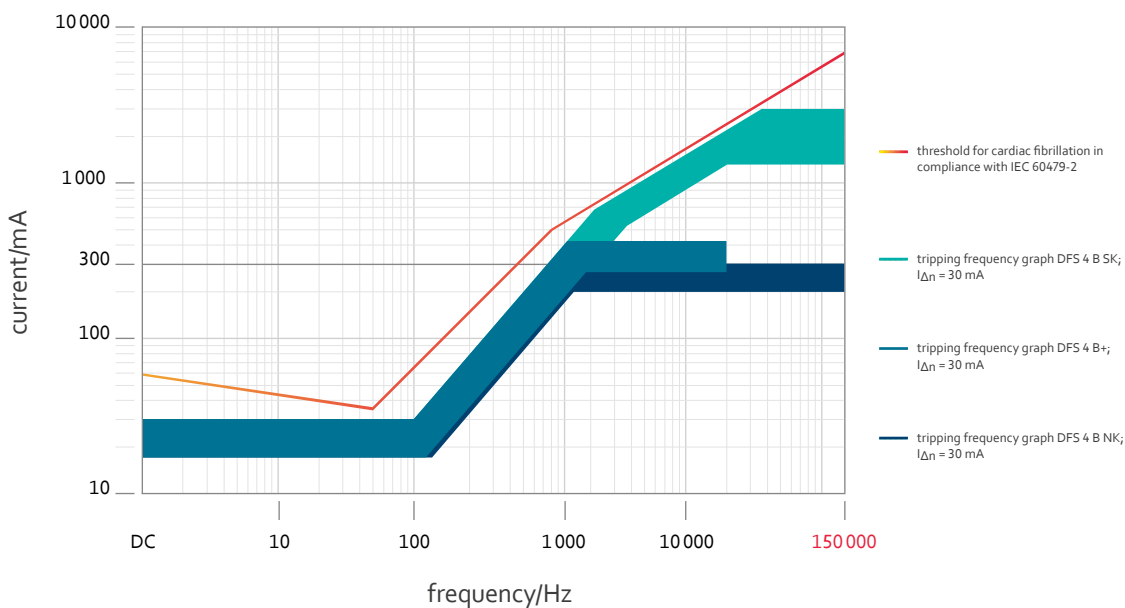

Our recommendations for a modern house distribution system

Type A

Residual current circuit-breaker DFS A

- for pulsating and alternating residual currents
- application areas: socket outlet circuits, conventional lighting

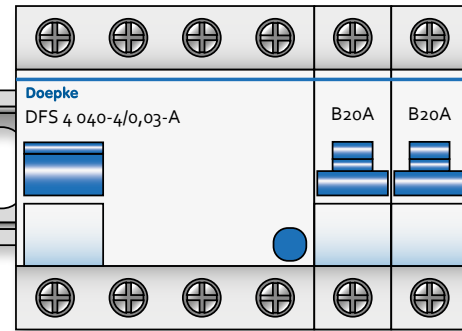

1 2

Type A KV

Residual current circuit-breaker DFS A KV

- for pulsating and alternating residual currents
- KV = short-time delayed, with surge current resistant
- significantly less nuisance tripping due to inrush currents from consumers such as: LED and fluorescent lamps or switched-mode power supplies
- recommended in DIN VDE 0100-530

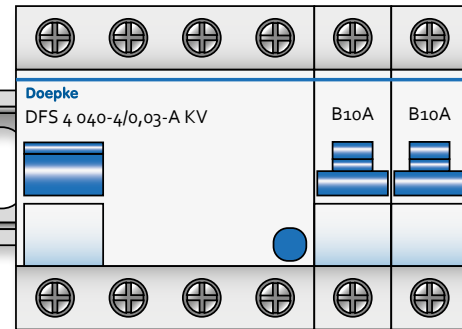

1 2

Type F

Residual current circuit-breaker DFS F

- for pulsating and alternating residual currents + residual currents with mixed frequencies
- short-time delayed and lightning-resistant
- new addition to DIN VDE 0100-530
- consumers with single-phase frequency converters: washing machines, heating or heat pumps, air conditioners

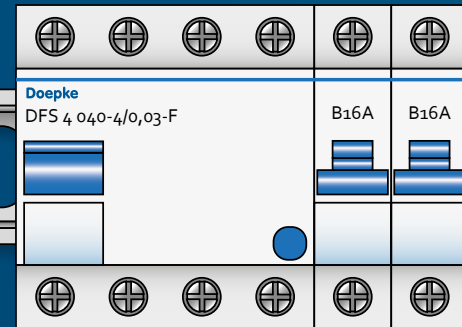

1 2

Tip: Type A and F in EV design:

Buyers are increasingly opting for electric vehicles in the private sector: Doepke also has residual current circuit-breakers in an EV (electric vehicle) design specifically for protecting against the DC residual currents that can occur when charging electric vehicles.

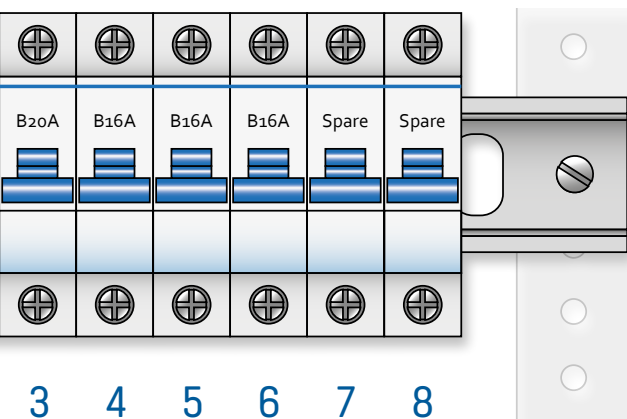

Miniature circuit-breakers DLS 6

— example assignment B 16 A/B 20 A:

- 1 –]
- 2 –] electric oven with hob
- 3 –]
- 4 – socket outlets
- 5 – freezer
- 6 – refrigerator
- 7 – spare
- 8 – spare

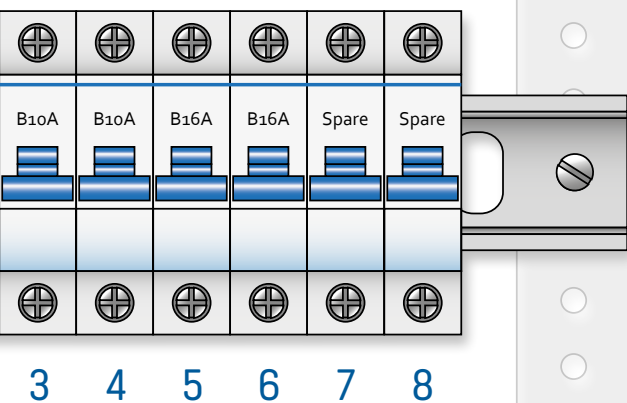

Miniature circuit-breakers DLS 6

— example assignment B 10 A/B 16 A:

- 1 – LED lighting
- 2 – LED lighting
- 3 – socket outlets
- 4 – fluorescent lamps
- 5 – ICT/switched-mode power supplies
- 6 – solar power systems
- 7 – spare
- 8 – spare

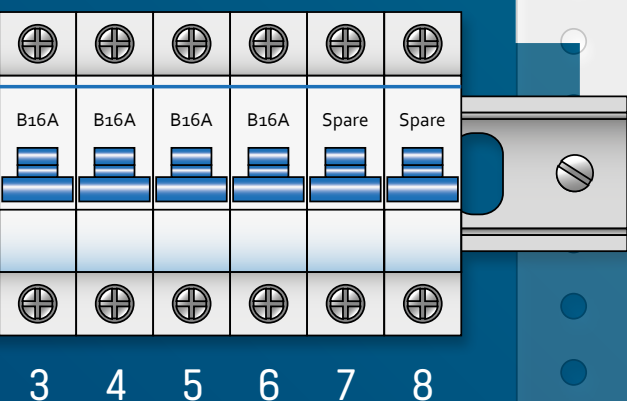

Miniature circuit-breakers DLS 6

— example assignment B 16 A:

- 1 – washing machine
- 2 – heating pump
- 3 – heat pump
- 4 – air conditioners
- 5 – vacuum cleaner systems
- 6 – other devices with 1-phase FCs
- 7 – spare
- 8 – spare

Standards that refer to the use of AC-DC sensitive RCCBs

DIN VDE 0100-530 ————— Low-voltage electrical installations; selection and erection of electrical equipment, switchgear and controlgear

DIN VDE 0100-704 ————— Requirements for special installations or locations, construction and demolition site installations

DIN VDE 0100-712 ————— Requirements for special installations or locations, photovoltaic (PV) systems

DIN VDE 0100-722 ————— Requirements for special installations or locations, supplies for electric vehicles

DIN VDE 0100-723 ————— Requirements for special installations or locations, classrooms with experimental equipment

DGUV Information 203-006 (BGI 608) ————— Selection and operation of electrical installations and equipment on construction sites

DGUV Information 203-032 ————— Selection and operation of power generators on construction and installation sites

DGUV Information 209-067 (BGI 5017) ————— Charging equipment for vehicle batteries

GDV Publications (VdS 3501) ————— Insulation protection in electrical installations with electronic equipment – RCD and frequency converters

VdS guideline 3145 ————— Guidelines from insurance providers for selecting, planning, erecting and operating grid-connected photovoltaic systems



Together we face the change
– with pioneering spirit and
60 years of experience in residual
current protection technology.

Andreas Müller, Managing Director

Selection tool app – Find the right RCCB immediately

Go directly to the correct solution
without any detours

There are RCCBs for all sorts of applications. It is not particularly easy to navigate your way around them and choose the right model for your needs. This app guides you through the extensive product range, taking you straight to the correct RCCB for your individual needs in just a few clicks.

- practical questionnaire
- find the right solution in just a few clicks
- free for iOS and Android

Download here

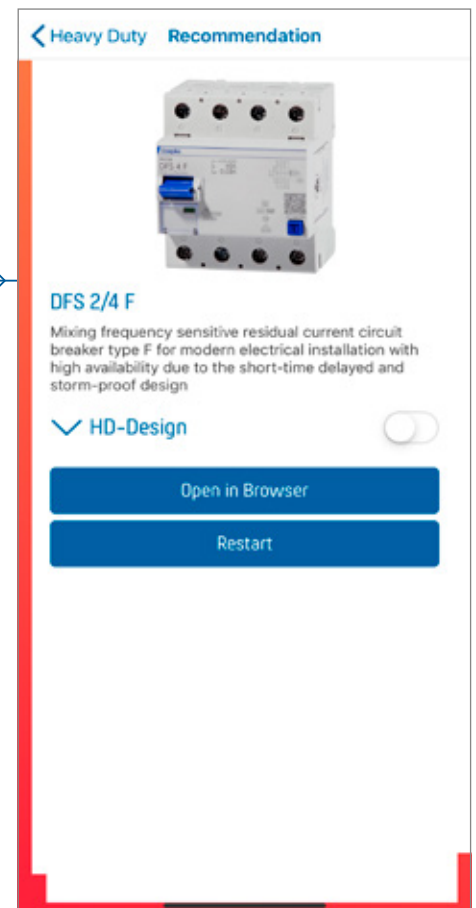
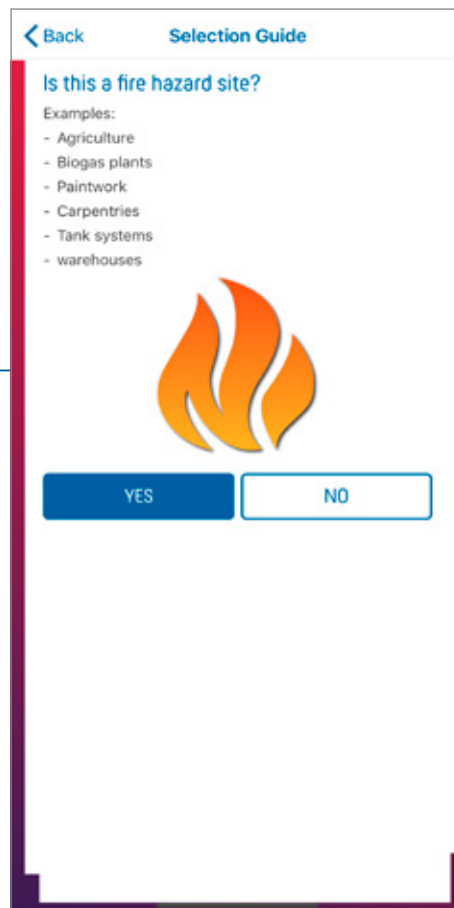
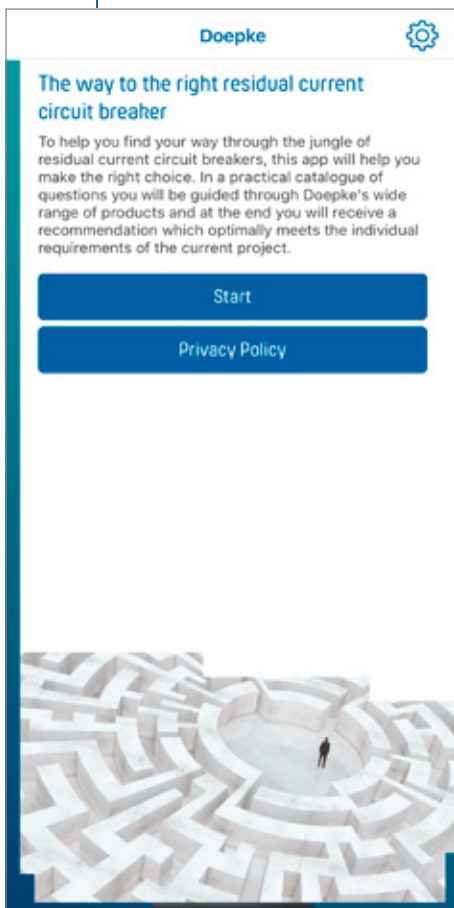

The right circuit-breaker for any requirement

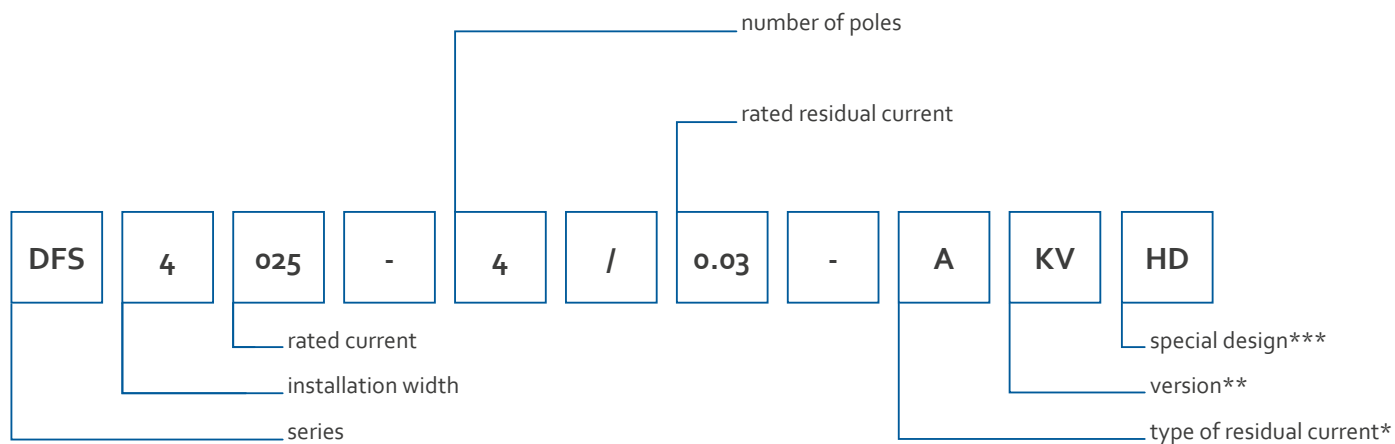

*type of residual current

- AC — type AC (AC sensitive)
- A — type A (pulsating current sensitive and AC sensitive)
- F — type F (mixed frequency sensitive)
- B — type B (AC-DC sensitive)
- B+ — type B+ (AC-DC sensitive)

**possible versions

- KV — increased surge current strength: considerably less sensitive to short-term pulsed residual currents
- S — selective: when RCCBs are connected in series
- FT — with remote tripping: enables functional testing from a distance
- V — rated voltage \neq 230/400 V
- Hz — for frequencies \neq 50 Hz
- W — point heater circuit-breaker, voltages up to 500 V
- SK — tripping threshold of 3 A for frequencies greater than 1 kHz
- NK — meets the conventional fire protection requirement of 300 mA up to a frequency of 150 kHz
- EV — for electromobility
- NA — emergency switching off according to DIN VDE 0100-723
- MI — for mobile installations
- IS Ω — insulation testing without the need for disconnection
- R — neutral conductor on the right
- Twin — two RCCBs in one device

***special designs

- HD — heavy duty design for harsh environmental conditions



The heavy duty version for tough environments.



Special environmental conditions require special protective measures

HD

— heavy duty

- the specialist for harsh environments
- virtually all DFS 2/4 devices are available in the HD special design
- ideal for construction sites, agricultural facilities, swimming pools, paint shops, car charging points
- less susceptible to corrosive gases, temperature fluctuations, corrosion
- non-stop protection, including in the de-energised state
- reason: uses special alloys and has a stainless steel latch
- ready for action 24/7/365

Always ready for action



Frost



Heat



Dust



Moisture



Corrosive gases

All-round protection in the lab and in experimentation rooms

NA

– emergency switching off

Whenever locations contain circuitry for experiments and tests, it is advisable and sometimes even mandatory (as stipulated by DIN VDE 0100-723) to incorporate an emergency switching off into the circuits. In addition to an AC-DC sensitive RCD, there must also be a remote-controlled emergency stop circuit. The technical requirements are clearly defined. For instance, they stipulate the use of a device that is capable of disconnecting all active conductors including the neutral conductor. In this case, the correct solution consists of AC-DC sensitive RCCBs with a residual operating current of no more than 30 mA. The Doepke DFS 4 B NA combines all of these properties in one device and offers maximum safety.

- continuous monitoring of the external emergency stop circuit
- allows the connection of emergency stop equipment, e.g. a button
- prevents reclosing of the RCCB while the emergency stop button is activated
- LED signals status of the emergency stop circuit
- auxiliary contact signals that the RCCB has tripped
- available as type A and type B
- suitable for use in accordance with the requirements of DIN VDE 0100-723



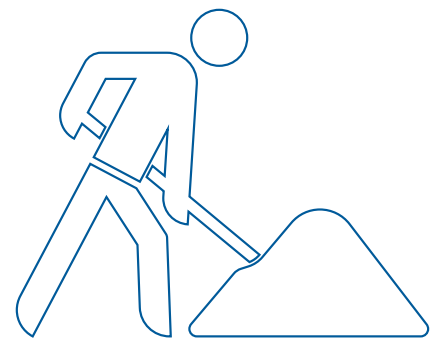

Series connection of different types

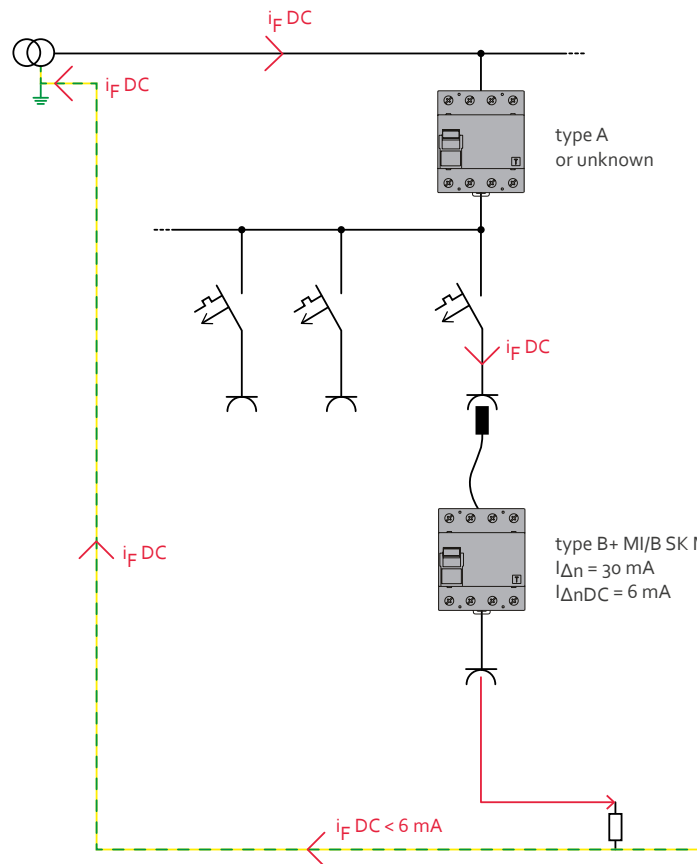

MI

— for mobile installations

Multi-phase frequency converters are used in mobile installations on construction sites, at festivals, funfairs or at similar locations/ events. These applications require type B RCDs. However, these must not be connected downstream of a type A RCCB or a device of an unknown type. Operators are often unaware of which type of RCCB is installed in the upstream fixed installation.

The DFS B MI is the only type B RCCB that can be installed downstream of a type A RCCB or one whose type is unknown. This means that it is always compatible, even if the type of RCCB in the upstream fixed installation is not known.

- trips from a DC residual current of 6 mA
- prevents pre-magnetisation of upstream type A RCCBs or those of an unknown type and safeguards their protective function
- the only type B RCCB that can be connected downstream of a type A RCCB
- ideal for electrical consumers that can cause DC residual currents and are used in different locations
- DFS 4 B+ MI for use in facilities at risk of fire
- DFS 4 B SK MI for high system availability: perfect for construction sites



We take the responsibility needed
to make energy efficient and safe to use.

Melanie Brandes, Team Leader Product Management

ST

– Selftest

RCCBs should be tested regularly. However, this usually involves disconnecting the power supply for the entire installation. The trouble is that even a short-term interruption of the power supply can cause problems for IT or telecommunications systems, on agricultural facilities, in small wind turbines or at sewage treatment plants. In these scenarios, what you need is an Selftest (ST) circuit-breaker. These devices regularly carry out an automatic function test on the RCCB – without interrupting the power supply and without the need for any additional wiring work.

- bypass contacts take care of the power supply and the residual current is continuously monitored
- available as type A with short-time delay

STR

– Selftest Restart

- in addition to the properties offered by the ST, the DRCCB 5 STR also recloses automatically after faulty tripping
- safety test performed in advance: thanks to easier measurement of the insulation resistance with safety extra-low voltage

The safe way to fill up with electricity

Residual current protection for charging – schematic diagram

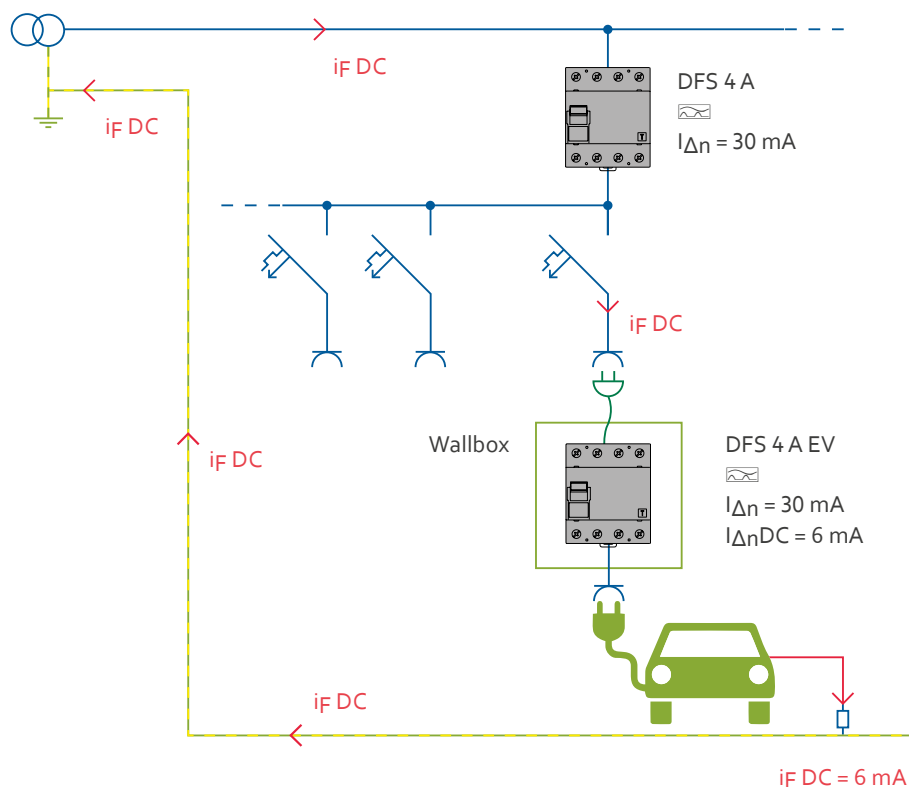

EV

– for electromobility

Smooth DC residual currents of a critical nature can occur when charging electric vehicles. Doepke has developed the EV (electric vehicles) design of its DFS RCCB specifically for charging electric vehicles. These circuit-breakers are VDE-certified to IEC 62955, detect smooth DC residual currents and trip at 6 mA DC. By using them, you can prevent the summation current transformer's core from becoming pre-magnetised (a phenomenon known as "blinding"). This protection extends to the RCDs that are being used themselves as well as to any upstream type A and type F RCDs.

- maintains reliable function of existing RCDs
- trips at max. 6 mA DC
- type A certified to IEC 62955
- no additional components required for residual current protection
- available in type A and type F
- optical display of DC detection via LEDs

Remote switching and signalling

DFA

remote actuators

After a RCCB has tripped, reclosing is not normally a problem, provided that the device is readily accessible. To prevent prolonged downtimes when installations are located some distance away, Doepke offers the DFA remote actuator. This additional device can be used to monitor the RCCB and, depending on the series, reclose it remotely after it trips. Depending on the design, the circuit-breaker is reclosed automatically three times.

- for monitoring the connected RCCB and – depending on the series – reclosing it automatically
- simple click-on connection
- status signalled via relay or semiconductor output
- DFA 2: four module widths
- DFA 3: one module width
- compatible with RCCBs from the DFS 2 and DFS 4 series



Accessories for RCCBs from the DFS 2 and DFS 4 series

WES reclosing lockout ————— prevents reclosing of the RCCB
————— for implementing protective measure “secure against reclosing”
during maintenance and repair work
————— additional security can be provided in the form
of sealing or a padlock

KA terminal cover ————— prevents accidental contact with live terminals
————— simple click-fit attachment

DHi 11 auxiliary/signal switch ——— operating mode can be selected
————— auxiliary switch signals when RCCB is closed or open
————— error signal switch merely signals tripping
————— ½ module width

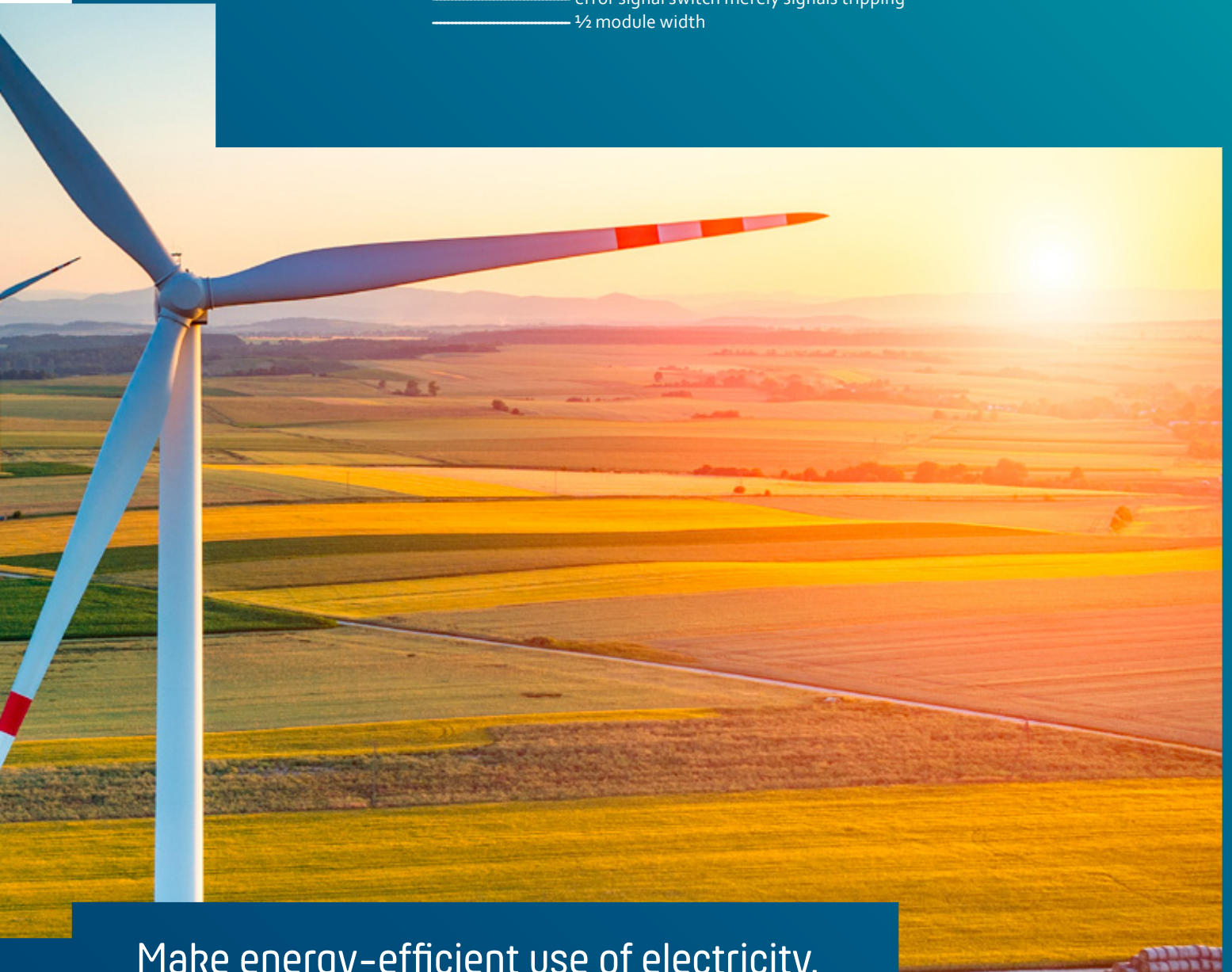

Make energy-efficient use of electricity.

Combined residual current and line protection: RCBO

Residual current operated circuit-breakers with integral overcurrent protection (RCBOs) are devices that offer combined residual current and line protection. They are the number one choice for reliable protection against residual currents, short-circuits and overloads when it comes to circuits in residential and purpose-built buildings. RCBOs can be used to divide up electrical systems so that only the affected circuit is switched off in the event of a fault.

DRCBO 3

- **integrated safety** ————— rapid troubleshooting: indicator triggered by residual current
- residual current type A (pulsating current-sensitive and AC current-sensitive) or type F (mixed frequency sensitive)
- “KV” design – short-time delayed: prevents unwanted tripping in response to surge currents during thunderstorms or, for example, when strip lights or computer systems are switched on
- line protection: tripping characteristics B and C available

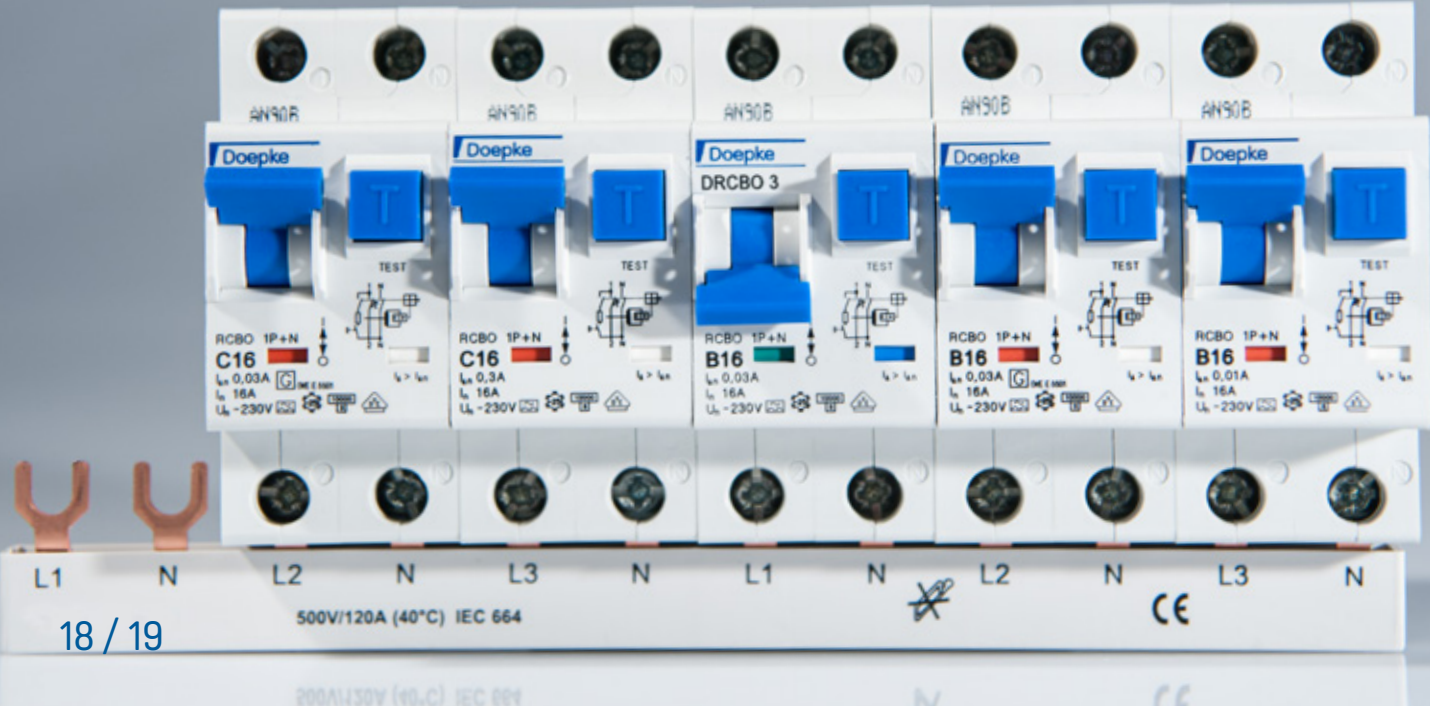



We make the use of electricity safe and provide exciting innovations and developments.

Gerold Roofs, Head of Development and Construction

DRCBO 4

— compact dual protection

Doepke now offers the residual current operated circuit-breaker with integral overcurrent protection in an even more compact form: the two-pole version of the DRCBO 4 B is no bigger than 2.5 module widths and the four-pole version just 4.5 module widths. In the event of an overload, short-circuit or residual current, only the faulty circuit is switched off.

In addition to the tripping characteristics already available, B SK and B NK, the residual current operated circuit-breaker with integral overcurrent protection is now also available in a B+ version.

- significant space saving
- rated currents up to 32 A
- rated residual currents in 30, 100 and 300 mA
- VDE-certified

Now available in an even more compact design

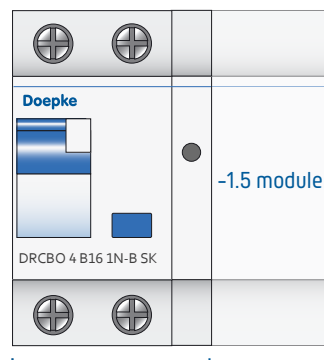

2.5 module widths instead of 4 module widths

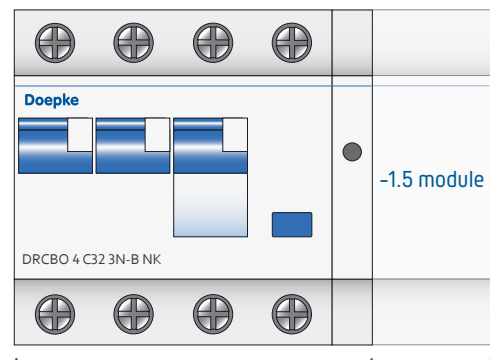

4.5 module widths instead of 6 module widths

Safety³ = DAFDD

Doepke's arc-fault detection device (AFDD) provides three-way security, combining residual current protection and line protection plus protection against dangerous arc faults in a single device measuring just three module widths. If the additional module detects series or parallel arc faults, it switches off the circuit affected, thereby providing reliable protection.

- DAFDD**
- three functions in a single device: RCCB + MCB + AFD
 - measures just three module widths
 - simple troubleshooting: signal indicates cause of tripping (LED flashing code, indicator triggered by fault current and contact position)
 - last AFD fault code is saved, can be read out again
 - integrated overvoltage protection (> 270 V)
 - self-monitoring of AFD unit – no manual function test required
 - residual current type A (pulsating current sensitive and AC current sensitive) and A KV (short-time delayed)
 - line protection: tripping characteristics B and C available

DIN VDE 0100-420 recommends using arc-fault detection devices in:

- premises with sleeping accommodation
- rooms or places where there is a particular risk of fire
- rooms or places made from flammable building materials
- rooms or places where irreplaceable goods may be at risk

The planner and/or constructor must carry out a risk assessment as early as the planning phase in order to determine whether the use of AFDDs needs to be considered.





More than just fire protection: one device, three functions

Electric arcs and arc faults in series and parallel

Electric arcs can occur for operational reasons when opening or closing mechanical contacts. These do not present any hazard.

However, even minor damage or insulation defects on conducting lines can cause undesirable arc faults. If these go unnoticed, they can become a fire risk in the electrical installation. Parallel arc faults are detected by MCBs and RCCBs, but series arc faults can go unnoticed if no AFD unit is present.

If these dangerous arc faults keep occurring for days, months or even years, they exert thermal stresses on the surrounding material, causing it to undergo changes and, in the worst-case scenario, leading to devastating fires.

Types of arc fault

series fault:

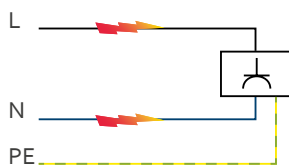

parallel fault:

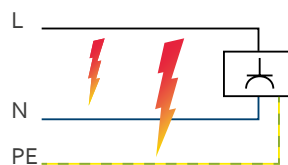

Fault code display (repeated three times)

- | | |
|--|-----------------------|
| ■ Continuously lit green: | normal operation |
| ■ 1 × yellow: | series fault |
| ■ 2 × yellow: | dimmer fault |
| ■ 3 × yellow: | parallel fault |
| ■ 4 × yellow: | overvoltage (> 270 V) |
| ■ 5 × yellow: | temperature (> 115°C) |
| ■ 6 × yellow + continuously yellow/red: | internal fault |

Expert line protection to keep you safe at all times

Miniature circuit-breakers (MCBs) protect cables, lines and installation devices against overloads and short circuits and – in turn – from damage and premature ageing.

DLS 6 The DLS 6 series provides a large selection of different types for use in residential and purpose-built buildings as well as the industrial sector. Its compact design leaves ample room for wiring. The DLS 6 MCBs can be easily installed due to their large terminal clamps and have universal applications thanks to the wide range of accessories available.

Protection elements The structure of the MCB consists of two protection elements.

Electromagnetic tripping

If the overcurrent increases to the point that it enters the short-circuit range (higher than or equal to the magnetic threshold), the magnet trip instantly reacts.

Thermal tripping

The circuit is interrupted if the rated current is exceeded for a prolonged period and is below the magnetic tripping threshold. The MCB will not react if the rated current is only exceeded briefly by a small amount.

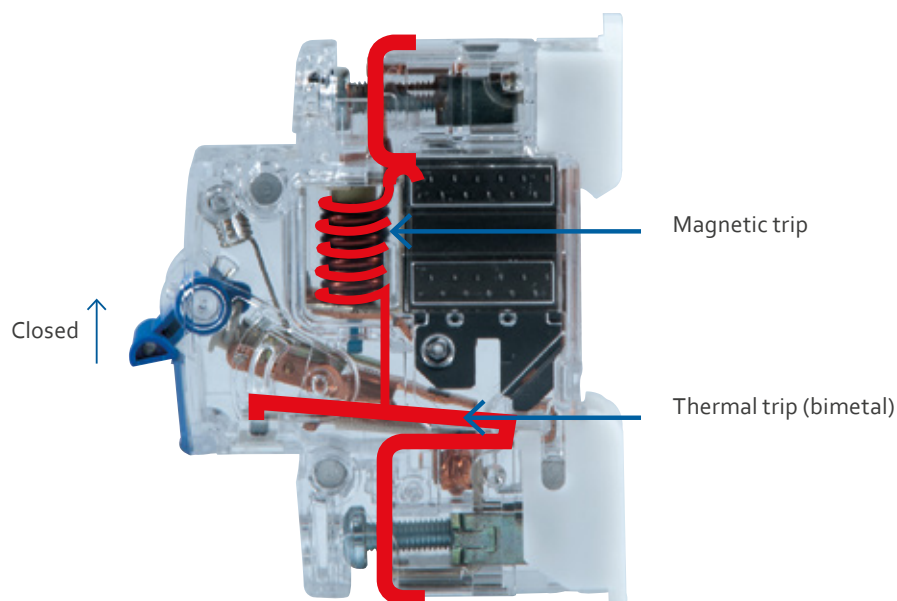

Overcurrent protective equipment, circuit-breaker, structure

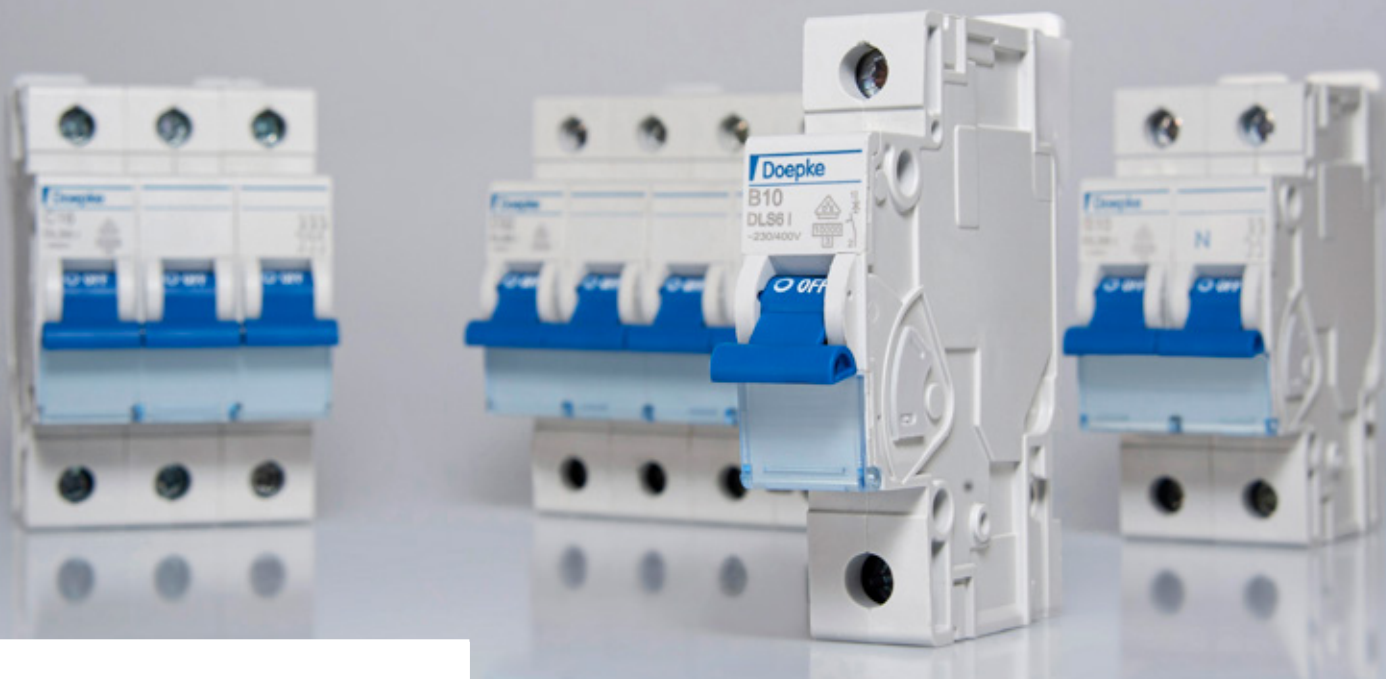

Product range

————— The fact that the system components are designed for different functions and levels of performance means that the range offers the ideal solution for a variety of applications:

DLS 6h ————— The DLS 6h design for skilled trade applications and conventional residential buildings features a rated breaking capacity of 6 kA, making it ideal for final circuits with low short circuit currents in domestic installations.

DLS 6hsl ————— The DLS 6hsl screwless design for industrial/commercial applications features a rated breaking capacity of 6 kA, making it ideal for final circuits with low short circuit currents in domestic installations. It is particularly easy to handle thanks to its upper, screwless plug-in terminals.

DLS 6hdc ————— The DLS 6hdc design features a rated breaking capacity of 6 kA, making it ideal for applications in DC networks of up to 250 V DC.

DLS 6i ————— The DLS 6i design features a rated breaking capacity of 10 kA, making it perfect for industrial and manufacturing applications.

Comparison of the different variants

	DLS 6h	DLS 6hsl	DLS 6hdc	DLS 6i
Switching capacity	6 kA	6 kA	6 kA	10 kA
Detachable from the combination	only from the bottom	only from the bottom	only from the bottom	top and bottom
Eurovario from RCD to circuit-breaker	only from the bottom	only from the bottom	only from the bottom	only from the bottom
Protection against direct contact	yes	yes	yes	yes
Tripping characteristic	B, C	B, C	B, C	B, C, D, K, Z

PREMIUM | **MARKEN**
Partner 

Doepke

Doepke Schaltgeräte GmbH
Stellmacherstraße 11
26506 Norden | Germany

@ — info@doepke.de
T — +49 (0) 49 31 18 06-0
F — +49 (0) 49 31 18 06-101

www — doepke.de